









Befestigungszubehör 1 Mounting Accessories 1



Gewindestifte • Mounting Studs

Typ • Model	021	003	005	043
Gewinde x Länge Thread x Length	M3 x 6	M5 x 8	M5-Bundschaube geg. Bodendehnung M5 anti-base strain adapter	M8 x 10
Foto Photo			M5 x 3 M5 x 7 	

Gewindeadapter • Mounting Adapter Studs





Typ • Model	022	046	045	044
Gewinde 1 x Länge 1 Thread 1 x Length 1	M3 (innen) x 5 M3 (female) x 5	M5 x 4	M5 x 4	M5 (innen) x 4 M5 (female) x 4
Gewinde 2 x Länge 2 Thread 2 x Length 2	M5 (außen) x 5 M5 (male) x 5	1/4"-28 x 4	UNF 10-32 x 4	M8 (außen) x 4 M8 (male) x 4
Foto Photo				

Isolierflansche zum Anschrauben • Insulating Flanges for Screw Attachment





Typ • Model	106	006	206
Verwendung Purpose	Zur isolierten Schraubbefestigung von Beschleunigungsaufnehmern For isolated screw mounting of accelerometers		
Foto Photo			
Gewindestutzen 1 x Länge Stud 1 x Length	M3x 1.4	M5 x 5	M8 x 6
Gewindestutzen 2 x Länge Stud 2 x Length	M3x 1.4	M5 x 3	M8 x 4
Durchmesser x Höhe Diameter x Height	12 x 3.7mm	SW17 x 4mm	30 x 10mm
Masse • Weight	0.7 gr.	2.5 gr.	16 gr.
Maximaltemp. Maximum temp.	110°C	80°C	110°C

Befestigungszubehör 2 Mounting Accessories 2

Befestigungspads zum Aufkleben • Mounting Pads for Adhesive Attachment

Typ • Model	129	329	029	229
Verwendung Purpose	Zum Aufkleben mit Sekundenkleber oder Epoxydharz für die isolierte (außer 229) Befestigung von Beschleunigungsaufnehmern For adhesive attachment with cyanoacrylate or epoxy glue for isolated mounting (except 229) of accelerometers			
Foto Photo				
Gew.stutzen x Länge Stud x Length	M3 x 1.4 mm	M3 x 3.5 mm	M5 x 3 mm	M8 x 4 mm
Durchmesser x Höhe Diameter x Height	12 x 3 mm	20 x 3 mm	15 x 1.6 mm	25.5 x 4 mm
Masse • Weight	0.5 gr.	1.5 gr.	1 gr.	16 gr.
Maximaltemp. Maximum Temp.	110°C	110°C	> 250°C	> 250°C

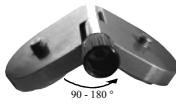

Seltenerd-Haftmagneten • Rare Earth Magnetic Bases*

Typ • Model	108	308	408	008	208	608
Verwendung Purpose	Haftmagnete mit hoher Zugkraft für Schwingungsaufnehmer Magnetic bases with high pulling force for vibration sensors					Kurvenmagnet Curved magnet
Foto Photo						
Gewinde • Thread	M3-Stutzen M3 stud	M3-Stutzen M3 stud	M4-Innengew. M4 hole	M5-Stutzen M5 stud	M8-Stutzen M8 stud	2 M5-Stutzen 2 M5 studs
Gewindelänge / -tiefe Thread Length / Depth	1.4 mm	2.7 mm	4 mm	3 mm	4 mm	3 mm
Durchm. / Höhe Diamet. / Height	10 mm / 5 mm	22 mm / 8 mm	30 mm / 11 mm	22 mm / 8 mm	30 mm / 11 mm	66 mm x 44 mm x 12 mm
Zugkraft Pulling force	20 N	100 N	100 N	100 N	100 N	100 N
Masse • Weight	2.5 gr.	20 gr.	64 gr.	20 gr.	66 gr.	112 gr.
Maximaltemp. Maximum temp.	80 °C	80 °C	80 °C	80 °C	80 °C	80 °C



* Weitere Modelle auf Anfrage • Other models on demand

Befestigungszubehör 3 Mounting Accessories 3

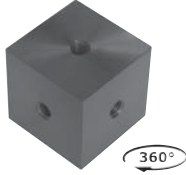

Triaxial-Montagewürfel • Triaxial Mounting Cubes

Typ • Model	130	030	230	330
Verwendung Purpose	Adapter für triaxiale Messungen mit drei einachsigen Beschleunigungsaufnehmern Adapters for triaxial measurements with three uniaxial accelerometers			
Foto Photo				
Gewinde für Sensoren Thread size for sensors	3x M3	3x M5	3x M8	3x M10
Befestigung am Messobjekt Mounting at test object	Gewindestutzen M5 M5 stud	Gewindestutzen M8 M8 stud	Gewindestutzen M8 M8 stud	Schraube M6 M6 screw
Kantenlänge • Size	12 mm	21 mm	34 mm	51 mm
Masse • Weight	3.5 gr.	20 gr.	95 gr.	340 gr.

Zubehör für die Messung von Humanschwingung • Accessories for Human Vibration Measurement

Typ • Model	140	142	144
Verwendung Purpose	Handgriff-Adapter zur Befestigung von Beschleunigungsaufnehmern mit M3-Gewinde auf gekrümmten Flächen Handle adapter for the attachment of accelerometers with M3 threads on curved surfaces	Handgehaltener Adapter für Beschleunigungsaufnehmer mit M3-Gewinden auf gekrümmten Flächen Hand-held adapter for accelerometers with M3 threads on curved surfaces	X / Y / Z Kalibrieradapter für den Sitzkissen-Beschleunigungsaufnehmer KB103SV-100 X / Y / Z calibration adapter for the seat pad accelerometer KB103SV-100
Foto Photo			

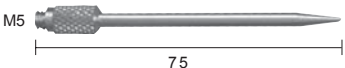
Sonstiges Montagezubehör • Other Mounting Accessories

Typ • Model	001 Tastspitze • Probe	002 Bienenwachs • Bee Wax
Verwendung Purpose	Für orientierende Messungen unter 1 kHz For estimating measurements below 1 kHz	Temporäre Befestigung von Sensoren unter 25°C Temporary mounting of sensors below 25°C
Foto Photo		 Schmilzt durch Handwärme / Heißluft Melts by hand warmth / hot air